

copyright © tekno' scientific srl all right reserved - made in italy

*vela*TM

a new concept of laboratory

TEKNO' SCIENTIFIC

PATENT
PENDING

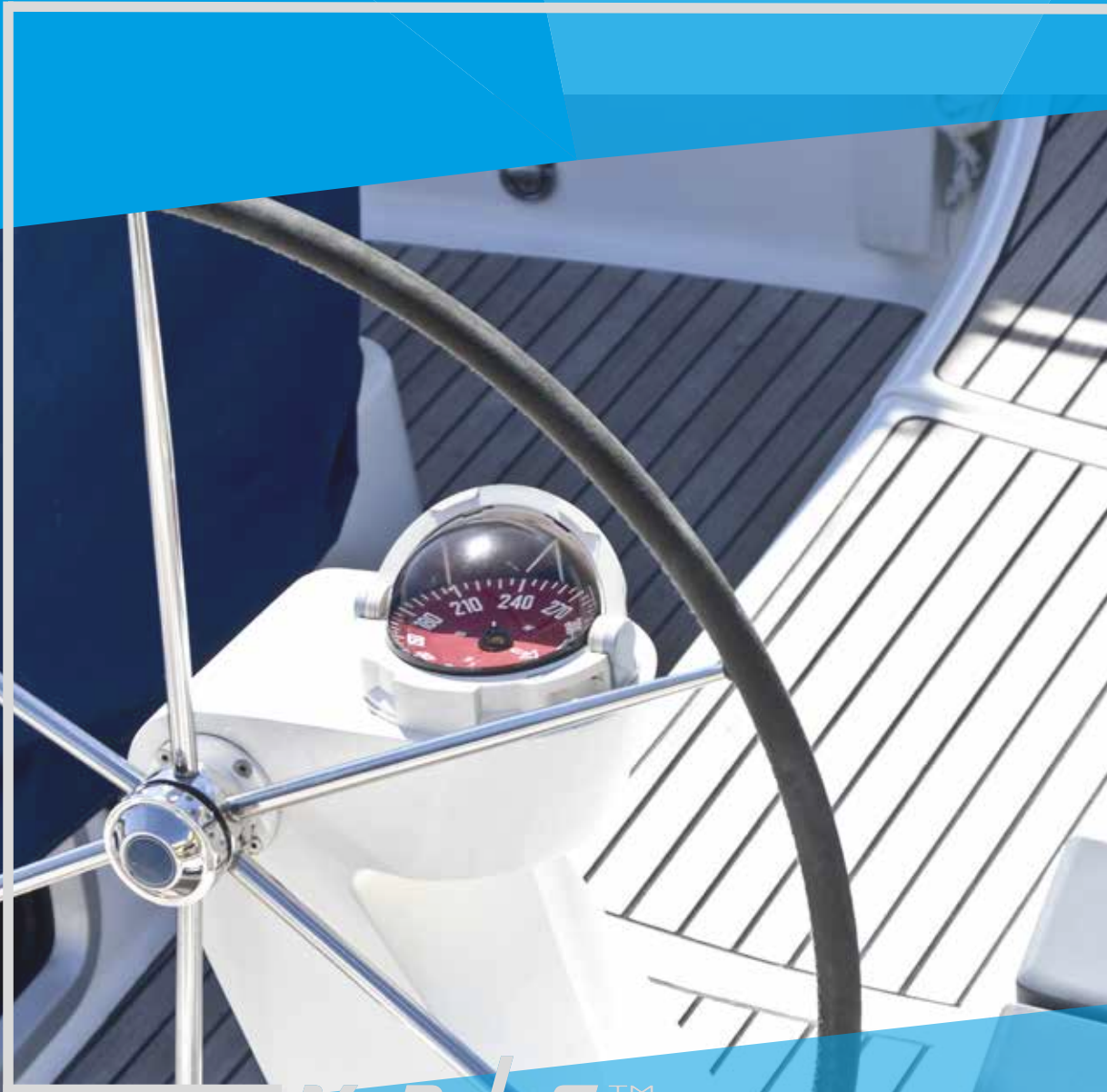

VELA™

VELA™

THE FUTURE

Un sistema dinamico di innovativa concezione, integrabile senza limiti.

Realizzato interamente con materiali riciclabili ed eco compatibili, altamente resistenti agli aggressivi e integralmente sanificabili.

A dynamic system of innovative design, integrated limitless.

Realized entirely by recyclable materials and environmentally compatible, highly resistant to aggressive and fully sanitized.

PATENT
PENDING



vela™



VELA™

LAB SOLUTIONS

Il sistema d'arredo VELA è progettato e sviluppato per consentire l'integrazione con le nuove tecnologie previste in laboratorio. Fornitura utenza tecnica a diversi livelli: alto, medio e basso; integrazione di dispositivi informatici, illuminazione, quadri controllo strumentazione.

The VELA furniture system is designed and developed to enable integration with new technologies provided in the laboratory, technical users supply at different levels: high, medium and low; integration of devices IT, lighting, control panels instrumentation.

PATENT
PENDING

vela™

1-Montante in alluminio 180x45 spessore 3-8mm con slitte per fissaggio e regolazione accessori.
1-Aluminum riser 180x45 thickness 3-8 mm with fixing slides and regulation devices.

2-Porta reagenti regolabile in altezza e profondità, versione con oblo'.
2-Adjustable door reagents in height and depth, version with porthole.

3-Ripiano a vassoio sanificabile.
3-Cleanable shelf cleanable tray.

4-Piano di lavoro regolabile in altezza.
4-Height adjustable work table.



PATENT
PENDING

veLa™

DETAILS

Alluminio satinato a vista profilati in acciaio e alluminio verniciati con speciale vernice epossidiche effetto laccato antiriflesso. Spalle con profilati aperti alluminio e acciaio a sezione full-open sanificazione integrale. Viterie cromate, piedini oscillanti antiscivolo. Sistema DINAMICO con regolazione a slitta.

Visible satin finished profiles, steel and aluminum painted with special epoxy anti-reflective paint lacquered effect. Shoulders with open aluminum and steel profiles full-open-section fully sanitized. chrome screws, oscillating ad anti slip feet. DYNAMIC system with slide adjustment.

1

2

3

5-Capsula porta utenze regolabile in altezza.
5-Height adjustable capsule door utilities.

6-Piano in corian®
6-Corian® work top



INNOVATION

Piani regolabili in altezza, armadietti su ruote oppure sospesi, configurazione easy panel : per configurazioni future dei servizi tecnici
cromatic design: studio e abbinamento dei colori per aumentare il confort negli ambienti di lavoro; ecofriendly: ogni componente è realizzato con materiali riciclabili 100%; esclusivo: la possibilità di poter integrare la strumentazione consente di creare stazioni di controllo, di progettare il laboratorio del futuro.

Height-adjustable shelves, cabinets on wheels or suspended, easy panel configuration: for future configurations of technical services; cromatic design study and matching of colors to increase comfort in the realized environments work ecofriendly: each component is made by 100% recyclable materials; exclusive: the possibility to be able to integrate instrumentation lets you create control stations, to design the laboratory of future.

1

1-Capsula servizi a doppio livello.
1-Services capsule at two levels.

2-Armadietto provvisto di ruote con blocco.
2-Underbench equipped with wheels with block.

v r l a™

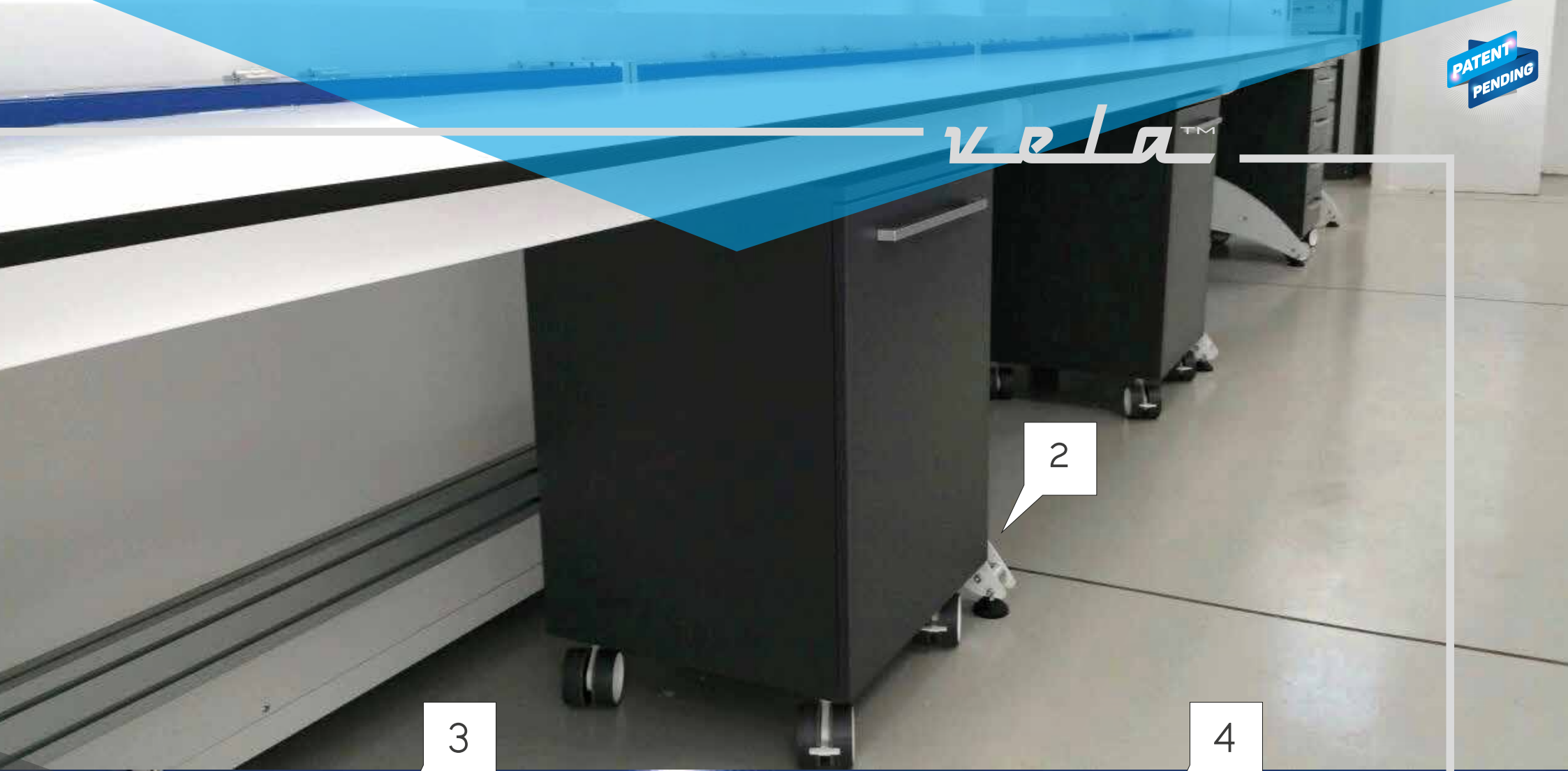

3

2

4



3-Pannello con rubinetti integrati, versione arretrata per minimizzare ingombro.
3-Panel with integrated taps, back version to minimize size.

4-Pannello con quadri elettrici Palazzoli certificati, prese ip55.
4-Panel with electrical panels Palazzoli certificates, sockets ip55.

PATENT
PENDING



*vela*TM

1-Ruota alta portata con piedino di sollevamento.
1-Hight range wheel with lifting leg.

2-Armadietto sospeso scorrevole orizzontalmente.
2-Under bench horizontally sliding.

3-Piano di lavoro resistente ai solventi LAB GRADE profondità 75-90cm
3-Work top 75-90 cm depth LAB GRADE solvent resistant

4

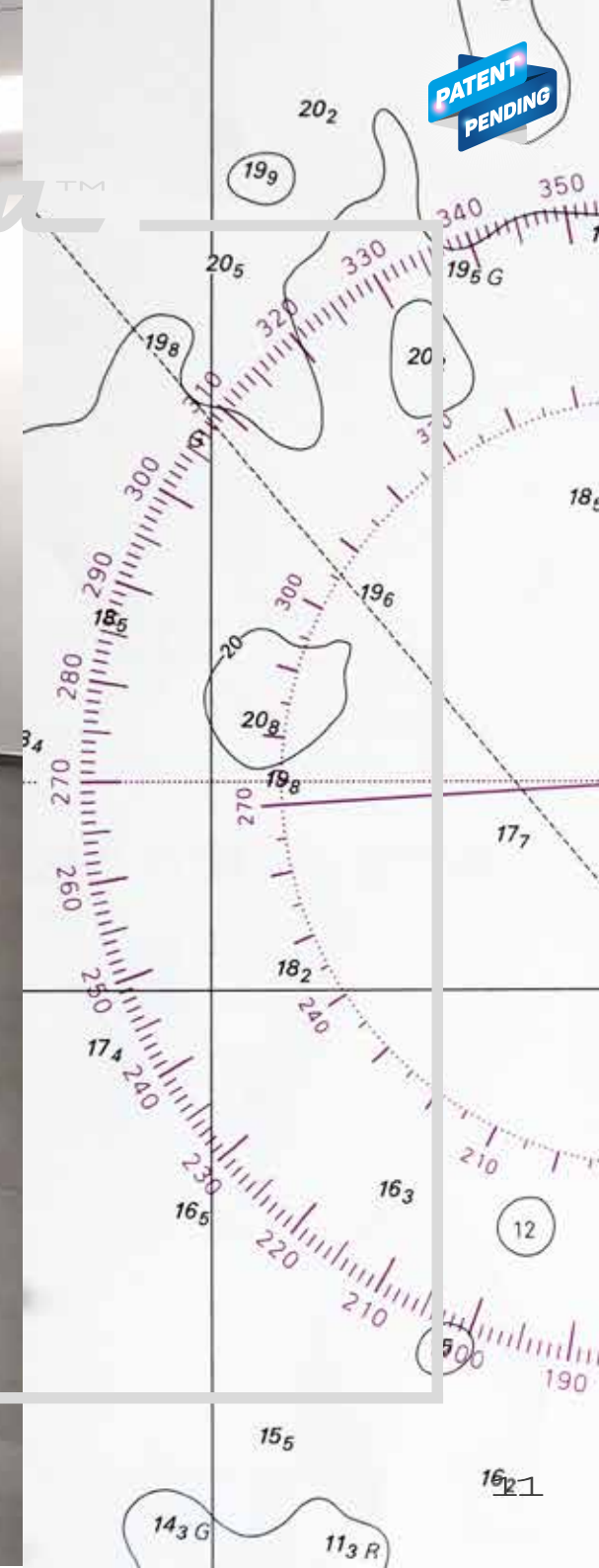

4-Sistema sospeso Satellite per erogazione utenze.
4-suspended System Satellite to provision utilities.

PATENT
PENDING



VELA™

PATENT
PENDING

VELA™

QUALITY

Il nuovo sistema d'arredo VELA è certificato da i prestigiosi laboratori del CATAS che ne testano la resistenza, la durata e la conformità costruttiva.

L'adozione di profilati d'alluminio e lamiere d'acciaio con spessori >2 mm, conferiscono al sistema doti di resistenza alla fatica e inalterabilità uniche.

The new system of VELA furniture is certified by the prestigious CATAS laboratories that test the strength, the durability and the constructive conformity.

The adoption of aluminum profiles and 2 mm thick steel plates give to the System fatigue resistance and unique durability.



PATENT
PENDING

1

2

VELA™

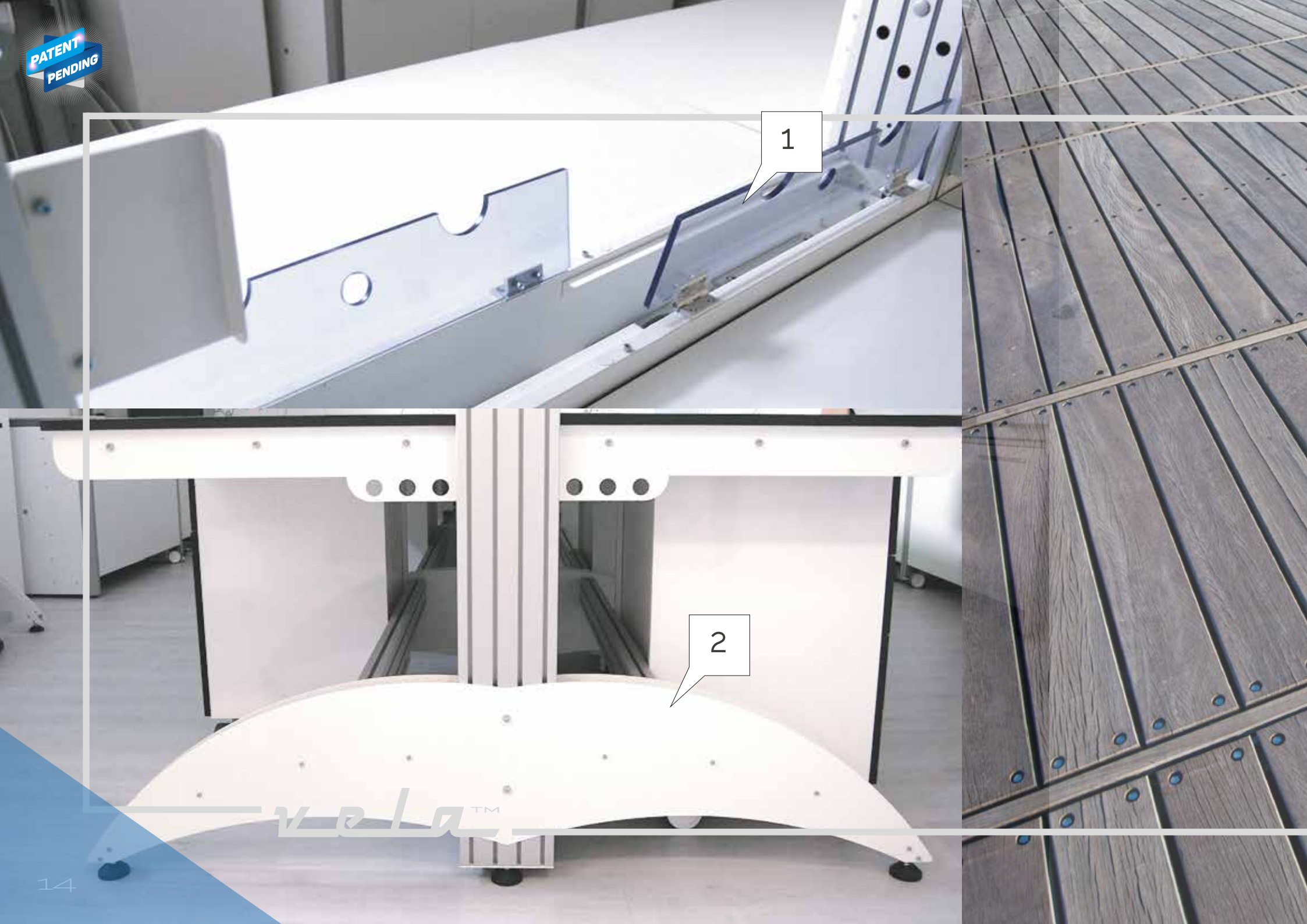

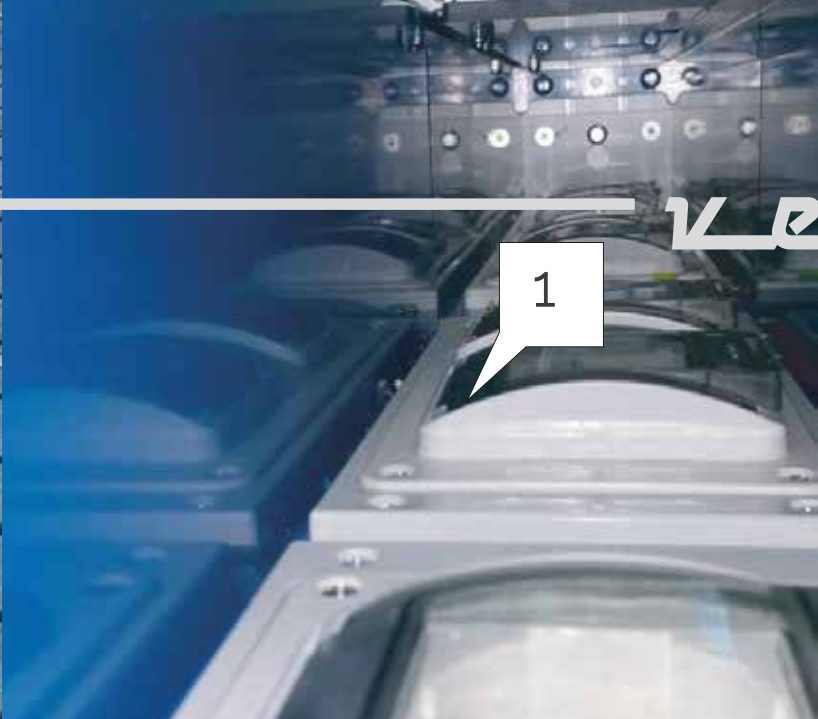

PATENT
PENDING

VELA™

1

3

1-NEWTUNNEL a scomparsa, predisposto per l'inserimento di quadri elettrici, rubinetterie sistemi di scarico strumenti, sportelli apribili in pvc trasparente, sistema per raccolta cavi.
1-NEWTUNNEL, adapted for the insertion of electrical panel, taps exhaust systems tools, opening doors in transparent pvc collection cables system.

2-Fianco VELA bifronte dal design esclusivo, conformazione che facilita la pulizia del pavimento.
2-Side-faced with unique design, VELA shape that makes easy cleaning of the floor.

3-Armadietto sospeso scorrevole orizzontalmente.
3-Under bench suspended sliding horizontally.

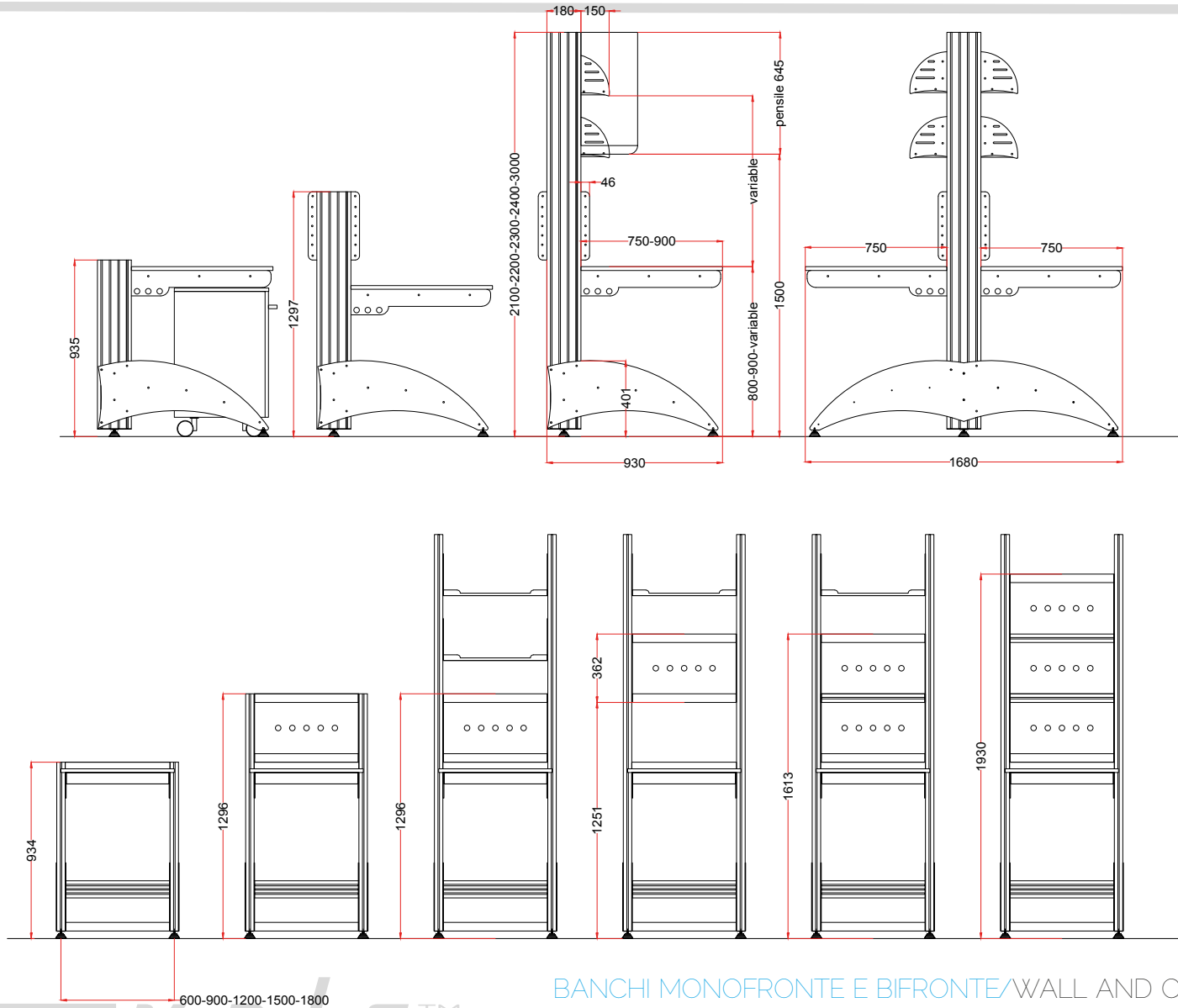

BANCHI MONOFRONTI E BIFRONTI/WALL AND CENTRAL BENCH



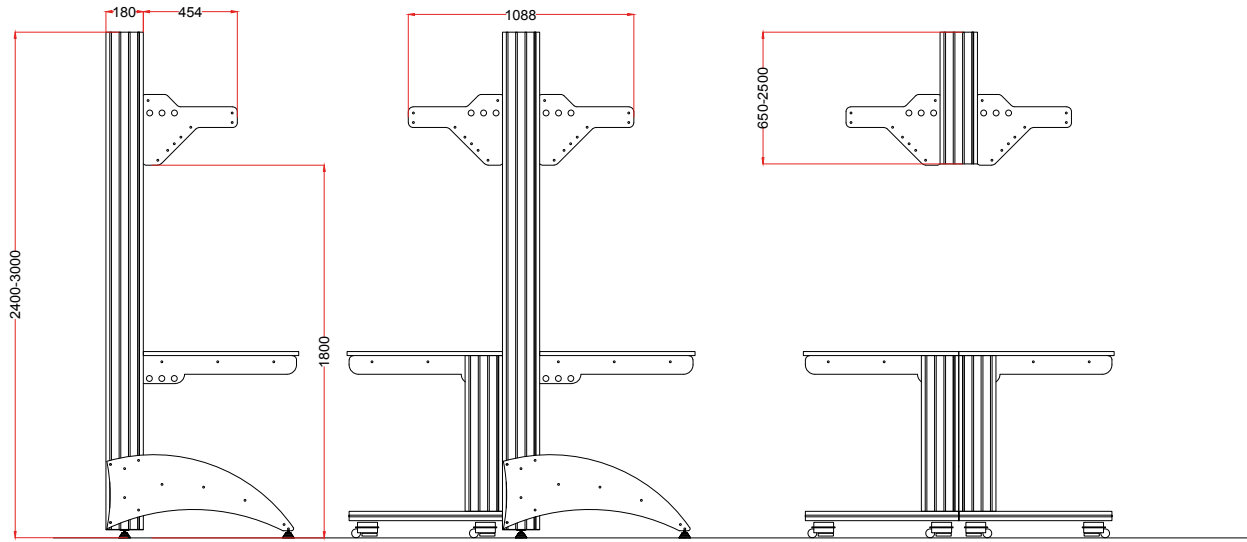

veLa™

STRUTTURE METALLICHE/STEEL STRUCTURES

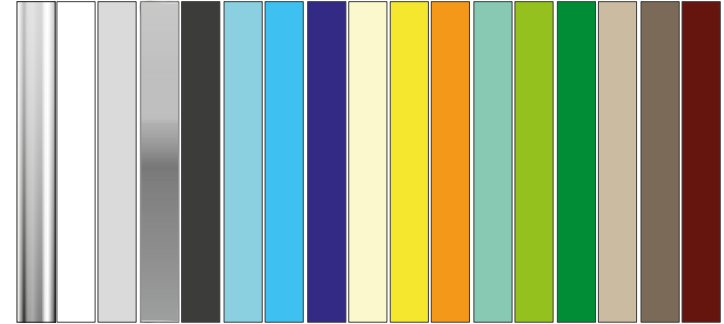

- ALLUMINIUM
- WHITE
- GREY
- SILVER
- ANTHRACITE
- SKY
- SEA
- NIGHT BLUE
- IVORY
- YELLOW
- ORANGE
- GREEN
- ACID GREEN
- FOREST
- TITANIUM
- BROWN
- BORDEAUX

BANCHI CARRELLATI (MOBILE) SATELLITE/MOVABLE BENCHES AND SATELLITE

MOBILETTI/UNDER BENCH

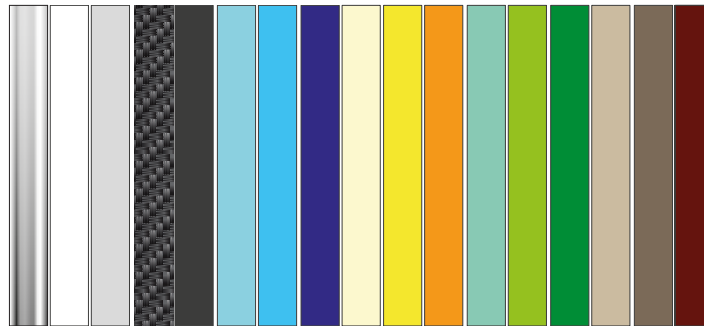
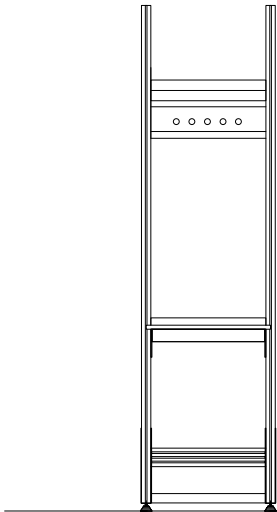

- ALLUMINIUM
- WHITE
- GREY
- CARBON
- ANTHRACITE
- SKY
- SEA
- NIGHT BLUE
- IVORY
- YELLOW
- ORANGE
- GREEN
- ACID GREEN
- FOREST
- TITANIUM
- BROWN
- BORDEAUX

PIANI DI LAVORO/WORK TOP

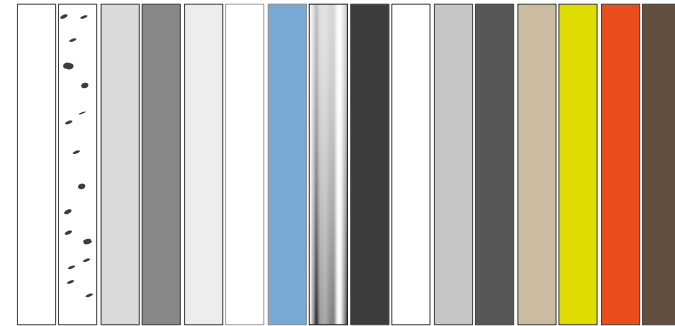

- LAB GRADE
- GRES-CERAMIC
- LAMINATE
- EPOXY RESIN
- POLYPROPYLENE
- GLASS
- VITRIFIED STEEL
- STAINLESS STEEL
- RUBBER
- CORIAN
- CORIAN
- CORIAN
- CORIAN
- CORIAN
- CORIAN
- CORIAN
- CORIAN

verificare disponibilità colori alcune colorazioni prevedono aggiornamento dei tempi di consegna e variazioni di prezzo. check availability colors. some colors provide with update on deliveries and price changes.

PATENT
PENDING

IL VOSTRO LABORATORIO/YOUR LAB



veta™

PATENT
PENDING



PATENT
PENDING

IL VOSTRO LABORATORIO / YOUR LAB



VELA™



PATENT
PENDING

vela

PATENT
PENDING

IL VOSTRO LABORATORIO / YOUR LAB



VELA™

PATENT
PENDING

vela™



PATENT
PENDING

IL VOSTRO LABORATORIO/YOUR LAB



vela™



PATENT
PENDING

VR/AR™

PATENT
PENDING

IL VOSTRO LABORATORIO / YOUR LAB

vela™

PATENT
PENDING

TEKNO™



TEKNO SCIENTIFIC SRL
PI 07165460960 REA MI 1940043



sede legale/registered office
Via Garibaldi, 39
20070 Vizzolo Predabissi

uffici, produzione, show room/warehouse, office
Via Puecher, 17
20060 Pozzuolo Martesana
Milano - ITALY



contact